

Design and analysis for interferometric measurements of the GMT primary mirror segments

J. H. Burge^{a,b}, L. B. Kot^a, H. M. Martin^a, R. Zehnder^b, C. Zhao^b

^aSteward Observatory, University of Arizona, Tucson, AZ 85721, USA

^bCollege of Optical Sciences, University of Arizona, Tucson, AZ 85721, USA

ABSTRACT

The Giant Magellan Telescope (GMT) uses seven 8.4-m diameter segments to create a giant primary mirror, 25 meters across with focal ratio $f/0.7$. The off-axis segments will be difficult to measure accurately, as they have 14.5 mm departure from the nearest fitting sphere! The test configuration adopted uses a large 3.75-m powered mirror to fold the light path and provide most of the aspheric correction, with a smaller mirror and computer generated hologram (CGH) providing the additional correction. These optics will be aligned to a vibration-insensitive interferometer using a combination of optical references created by the CGH and metrology with a laser tracker. Some key challenges for this system are presented here including, the system alignment, the large fold mirror, and the mechanical structure. Analysis of the optical test shows that it will meet GMT specifications, including the difficult requirement that the separate segments have matching radius of curvature. Additional corroborative testing will be performed to assure that the mirror segments are correctly figured.

Keywords: telescopes, optical fabrication, optical testing, aspheres

1. INTRODUCTION

The GMT uses a close packed array of seven 8.4-m segments to create the 25-m $f/0.7$ primary mirror.¹ This steep focal ratio minimizes the length of the telescope, but it drives the aspheric departure to be quite large. The telescope and a plot of the 14.5-mm aspheric departure for one of the segments are shown in Figure 1. This aspheric departure is compensated using mirrors and a computer generated hologram to allow an interferometric surface measurement.

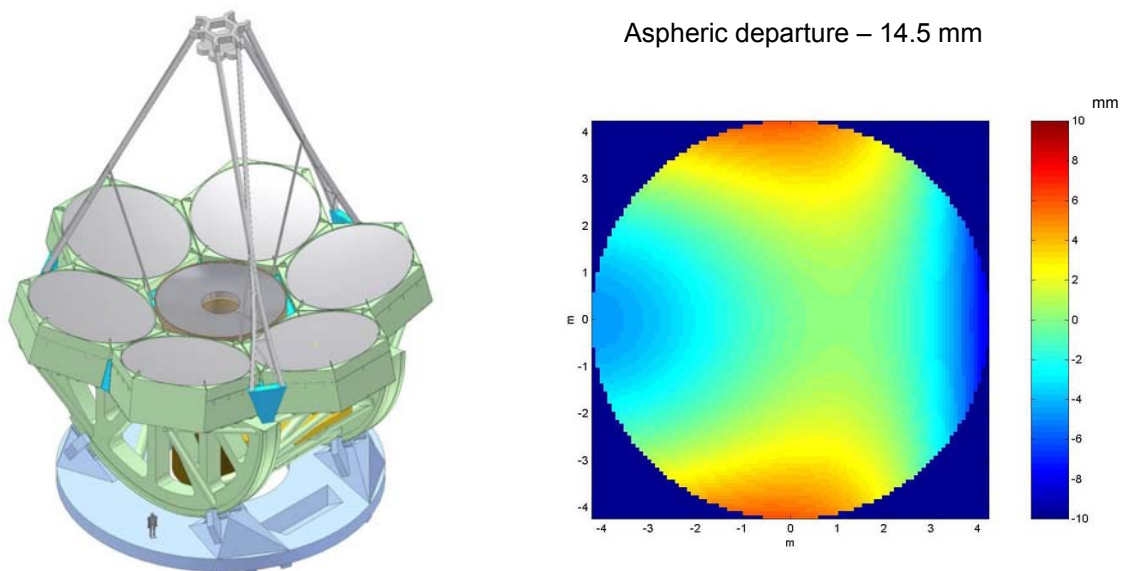

Figure 1. The 25-m $f/0.7$ GMT primary mirror is made of 8.4-m diameter segments. The off-axis segments have 14.5 mm departure from the best fitting sphere.

1.1 Requirements for optical testing

The requirements for the optical measurements are derived from the telescope system specifications. These flow down as contributions to budgets for wavefront, support force, or geometric tolerances, as shown in Table 1.

Fabrication errors in primary mirrors are allowed to contribute a structure function that corresponds to atmospheric seeing with 80% encircled energy θ_{80} of 0.166 arcsec, with a goal of achieving images with θ_{80} of 0.054 arcsec.² Since the mirrors will be polished based on data from the interferometric test, we assume that errors in the optical test contribute directly to errors in the mirror surface. We have allocated a goal for optical testing errors that has a structure function 60% as large as the specification for the surface.

Our experience with large primaries indicates that we will meet the requirement with significant margin over spatial scales less than 3 cm, where the polishing tools achieve excellent smoothing, and scales greater than 20 cm where the errors are easily addressed in polishing. This is easily seen in Figure 2 showing the GMT goal with the structure function data from LBT.

The active support for the primary mirrors, which uses 165 force actuators to control the mirror bending, is capable of large amplitude correction for the very lowest bending modes. Thus low-order shape errors due to either polishing or metrology will be corrected in the telescope with the support. We allow 50 N rms actuator force variation to accommodate mirror errors, out of an average force of 1070 N per actuator at zenith.

Additional specification include tight tolerances on off-axis distance and clocking angle (rotation of the segment about its mechanical axis) in order to limit displacements of the segments relative to their cells, which are fixed in the telescope. There is also a tight requirement for matching radius of curvature among all seven segments. The segments' radii must be fabricated well enough in the lab that they can be adjusted in the telescope using the active support to give essentially a perfect match in the telescope. The force required to make this adjustment contributes to the 50 N rms budget.

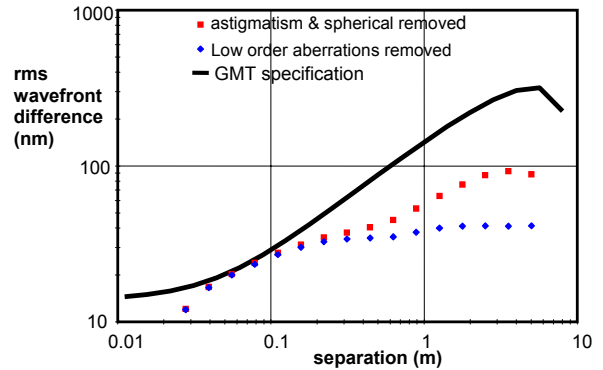

Figure 2. Structure function requirement for GMT, shown with data from a completed 8.4-m LBT primary mirror

Table 1. Error budget for GMT primary mirror segments, including allocation for optical test

Parameter	Primary mirror		Optical Test
	Specification	Goal	Allocation
Radius of curvature R	$36,000.0 \pm 1.0$ mm	± 0.3 mm	± 0.3 mm
Conic constant k	-0.998286		
Clear aperture	8.365 m		
Off-axis distance	8710 ± 2 mm	± 1 mm	± 1 mm
Clocking angle	± 50 arcsec		± 50 arcsec
θ_{80} for structure function	0.166 arcsec	0.054 arcsec	<60% of SF for 0.166 arcsec
Scattering loss L at $\lambda = 500$ nm	< 2.0%	< 1.5%	
Actuator correction forces	< 50 N rms		<25 N rms

We have imposed an additional requirement for the program – that redundant optical measurements are required for each important parameter. We are developing an independent measurement for large scale mirror surface and slope errors, as well as a method of calibrating small scale test errors and for fine sampling the edge. These tests are addressed in a separate paper in this conference.³

1.2 Heritage for measuring, large aspheric mirrors

The University of Arizona has developed techniques and facilities for measuring large, highly aspheric optics such as the 8.4-m diameter $f/1.1$ primary mirrors for the Large Binocular Telescope (LBT).⁴ We use an interferometer with null lens at the center of curvature of the mirror under test.⁵ The null lens that compensates the aspheric departure consists of a set of lens elements that are aligned using axisymmetry. This system is then calibrated using a computer generated hologram.⁶

The testing for GMT requires a new methods and hardware due to the off-axis nature of the segment, the very large aspheric departure, and the long radius of curvature. We cannot use axisymmetry as we have in the past and we cannot use a simple CGH because the magnitude of the aspheric departure is so great. In addition, because the GMT radius of curvature is so long, we do not have access to the radius of curvature in our shop. These issues are shown graphically in Figure 3.

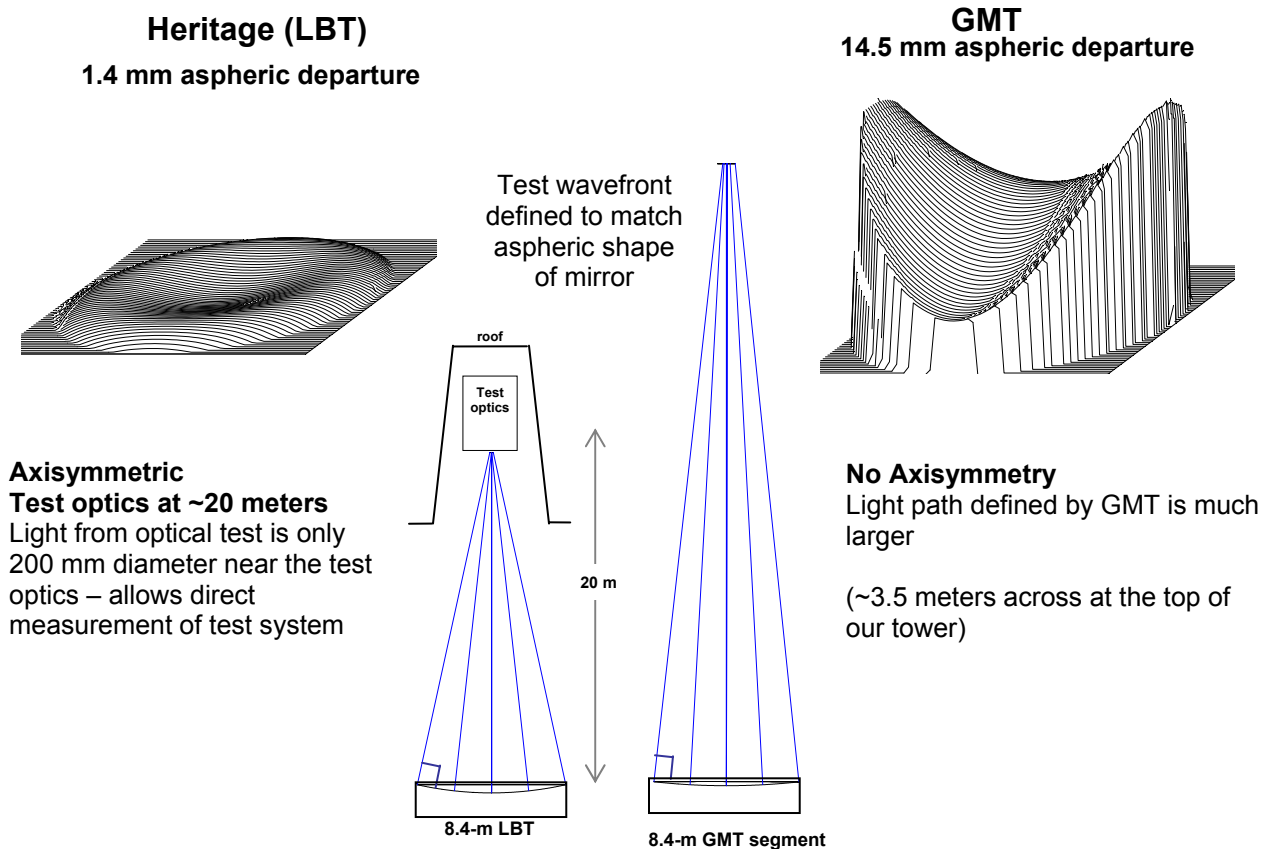

Figure 3. The shape measurement of the GMT segments provides several new challenges, the amount of aspheric departure is large and non-axisymmetric, and the long radius of curvature does not allow direct access in our shop.

As a stepping stone to GMT, we developed an interferometric test for a 1.7-m off axis parabola, which is roughly 1/5 scale for GMT.⁷ This design uses a tilted spherical mirror to compensate most of the aspheric departure. In addition, a computer generated hologram (CGH) provides both the residual wavefront correction and alignment references for the system. The optical test layout and the tower design are shown in Figure 4.

The different patterns on this complex CGH are used to provide optical references for the alignment of the CGH relative to the interferometer, for the positions of tooling balls that define the position of the spherical mirror, and for defining the nominal location of the 1.7-m mirror under test.⁸ (See Figure 5.) The 10- μm positional tolerance for the CGH and the mirror were achieved using these references. This optical system was successfully used to guide the polishing of this highly aspheric mirror.⁹

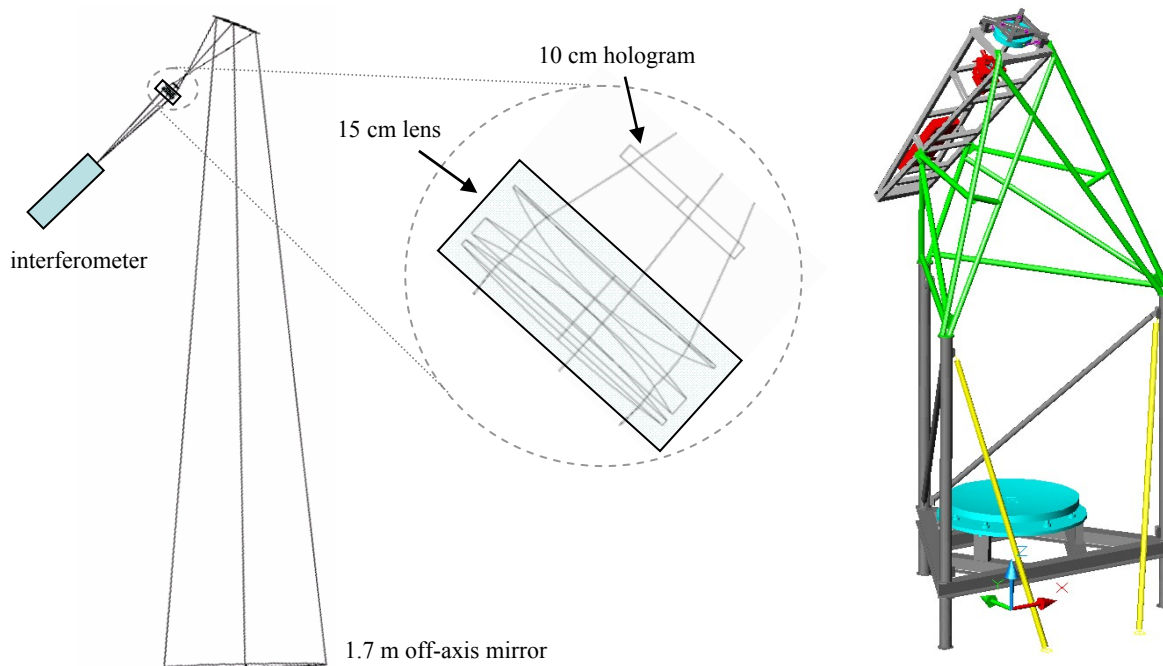

Figure 4. The 1.7-m off axis mirror, which is 1/5 scale for the GMT segments, was measured using a null corrector consisting of a tilted spherical mirror and a complex computer generated hologram. The assembly was mounted in a tower above the 1.7-m mirror.

10 cm CGH pattern for measurement of 1.7-m mirror
 (Each line here represents 350 lines in the real pattern)

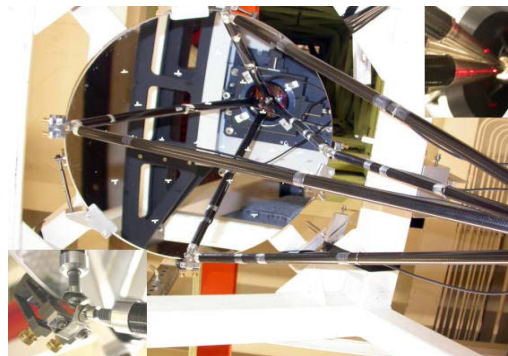
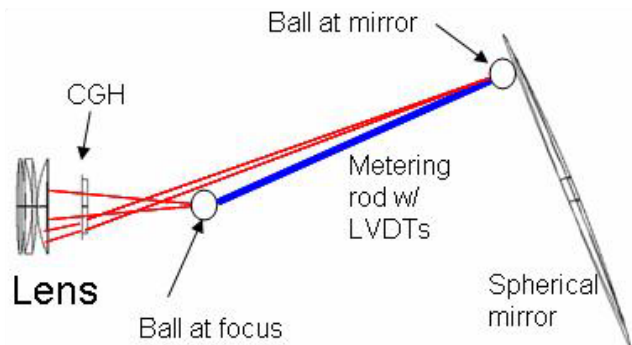
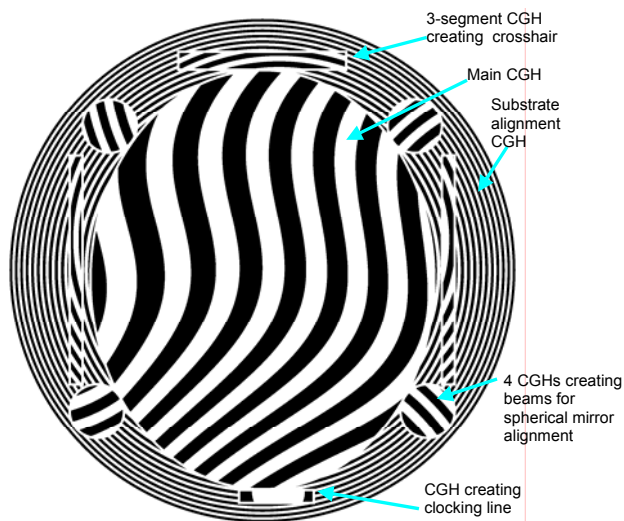

Figure 5. The CGH used 10 total patterns, used for alignment in addition to wavefront correction. The different patterns provide reference for aligning the CGH to the interferometer, aligning the 50 cm mirror, and positioning the 1.7-m mirror. The spherical mirror position was determined using four tooling balls. The lateral position of each ball was defined by light from the CGH and the axial position defined using mechanical metering rods as shown.

2. DESIGN AND ANALYSIS OF THE INTERFEROMETRIC TEST

The interferometric test was designed to allow a full aperture null measurement and to fit within the Mirror Lab. An alignment plan was devised that builds on the experience from the 1.7-m test and will provide reference of sufficient accuracy to meet the GMT error budget.

2.1 System configuration

The null corrector for the GMT segment uses a 3.75-m spherical mirror mounted with 14.2° tilt 23 meters from the GMT segment. This mirror folds the optical path, keeping it within our building, and also compensates much of the aspheric departure. A second, 75-cm mirror provides an additional relay to a 12-cm CGH, which provides the remainder of the high-order correction. The layout of this test is shown in Figure 6. Some key features of this test are:

- Moderate alignment tolerances $\sim 10\ \mu\text{m}$ for CGH, small sphere, $\sim 100\ \mu\text{m}$ for large sphere.
- Limits the volume of the test to a value that fits within the Mirror Lab
- Provides internal focus between the two mirrors to be used for alignment
- Center of curvature for the 3.75-m fold sphere is accessible for *in situ* testing of this mirror
- Utilizes vibration insensitive interferometer from 4D Technologies
- Builds on experiences and methods from the test of the 1.7-m mirror

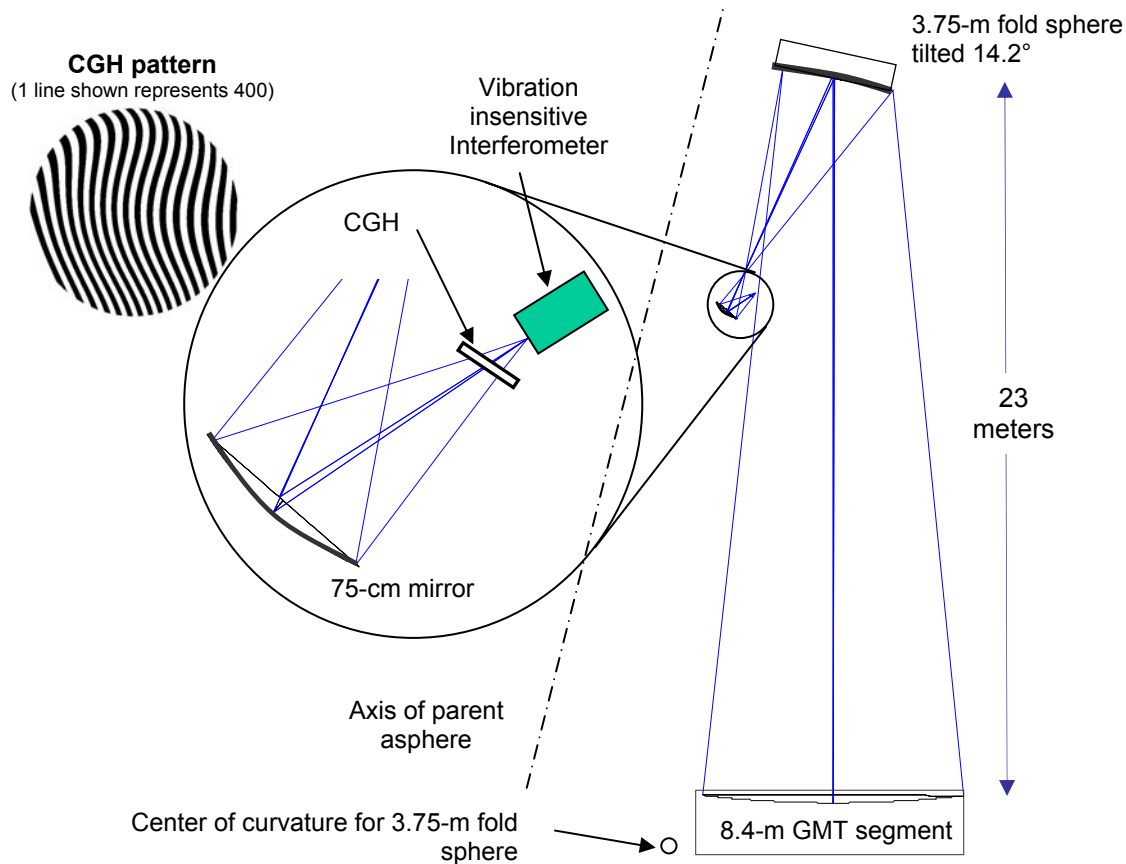

Figure 6. Optical layout for the interferometric test for the off axis GMT mirror segment

The test configuration also introduces new challenges:

- Requires fabrication and mounting of 3.75-m diameter high-quality mirror
- Requires major reconstruction of the Mirror Lab test tower
- Fine alignment must be performed by moving the 8.4-m mirror, rather than by moving the test optics.

2.2 Alignment methodology

The alignment method for the optical test builds on methods that have been successfully implemented for other tests. The alignment of the CGH to the interferometer and the subsequent alignment of the 75-cm spherical mirror can be accomplished using the same techniques as those presented above for the testing of the 1.7-m mirror. We will require good mechanics for the mounts, but we will not require thermal stability of invar; steel will be adequate.

We make explicit use of the intermediate focus between the two mirrors for alignment and calibration of the system. In this region, we place a small 120x70-mm computer generated hologram that reflects light back through the 75-cm mirror and CGH into the interferometer. We can use the reflected wavefront as feedback for positioning this CGH in the optical beam in the same way as we align the CGH for null corrector calibration.⁶ This CGH will be kinematically located so we can insert it for alignment testing, and remove it for operation. Then this CGH serves three functions:

- It provides an independent test of the wavefront from the main CGH, reflected for the 75 cm mirror.
- It provides an alignment datum for positioning the 3.75-m mirror.
- Allows additional holograms that to provide alignment cross-checks

We use a dedicated laser tracker to measure the relative positions of the optics for this test. The laser tracker is a three-dimensional coordinate measurement system that measured positions of retroreflectors using combination of gimbal angles and line of sight absolute distance measuring (ADM). Trackers are commercially available that will achieve 2σ accuracy of 50 μm for our measurements. Our requirements, based on the error analysis presented below, are much looser at $\pm 100 \mu\text{m}$.

We use a laser tracker to determine the relative positions of the intermediate CGH, the 3.75-m fold sphere (making use of its center of curvature reference), and the GMT segment. The assembly with interferometer, CGH, and 75-cm mirror is then aligned relative to the CGH. We place sphere mounted retroreflectors (SMRs) at key locations and simply measure their positions using the laser tracker. We use the absolute distance measuring (ADM) mode in the tracker for these measurements so we do not require an uninterrupted beam. The relative positions of the optics are then actively controlled using feedback from the laser tracker. This procedure is shown below in Figure 7.

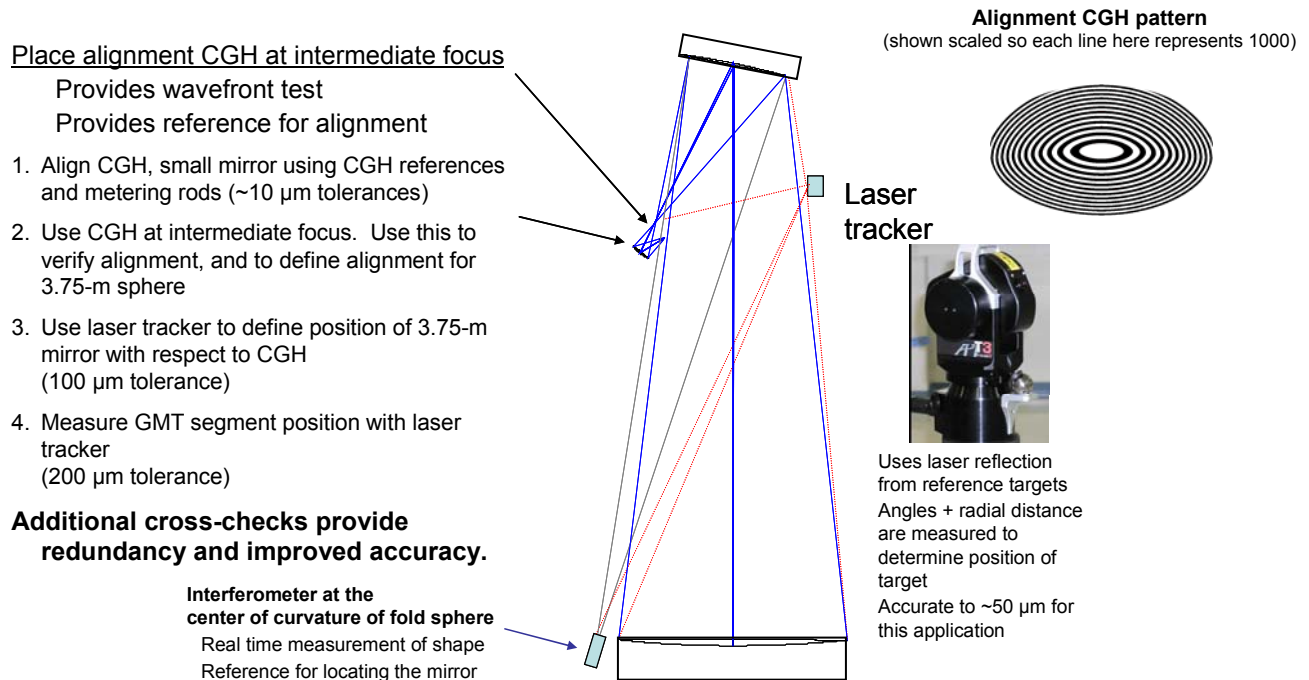

Figure 7. System alignment method, using CGH at intermediate focus and real time measurements with the laser tracker.

2.3 Error analysis for GMT interferometry

Detailed error analysis was performed for the GMT optical measurements to guide the engineering and to assure that the measurement will meet GMT goals. The analysis was performed to determine *the effect in the telescope* of any errors in the optical test. In operation in the telescope, we will perform the following sequence:

1. Install mirror segments using coarse mechanical measurements
2. Measure wavefront using star light
3. Move mirror segments to optimize wavefront:
 - a. translate in radial direction
 - b. rotate about segment center (clocking)
 (There is NO ALLOWANCE for axial spacing adjustment to compensate power.)
4. Bend mirrors to correct other shape errors, including power.

The analysis of the test optics simulates the same operations. The effect of imperfect optical testing will be:

- Shift in the segment positions, which must be limited to ~2 mm
- Actuator forces required for the active optics, which are budgeted at 25 N rms
- Residual wavefront errors that are not corrected, which are budgeted as 60% of the mirror structure function.

Once the telescope is coarsely aligned, the mirror segment positions are adjusted to optimize performance. In this case the telescope performance is defined by the actuator forces and residual surface errors after bending. We decompose the allowable rigid body segment motions into two terms, radial position which is a radial shift of the segment relative to the parent axis, and clocking or rotation about the segment's center. These motions are optically equivalent to shape changes as shown in Figure 8

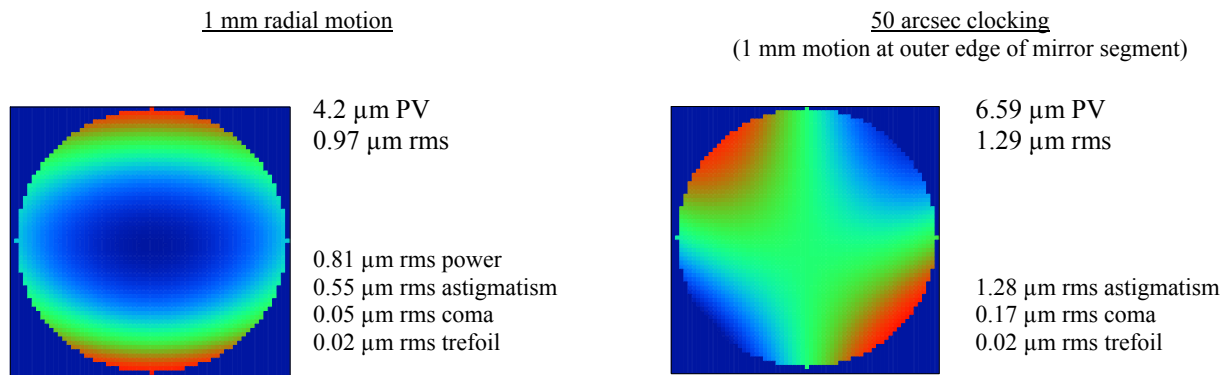

Figure 8. Effective change in optical surface that is seen for rigid body motion of the mirror segments.

The segments are adjusted to minimize the actuator force required after adjustment. Since astigmatism is a very “soft” mode, requiring only 13 N rms per μm rms, the radial position is mostly used to compensate power (with modal stiffness of 38 N rms/ μm rms) and coma (modal stiffness of 150 N rms/ μm rms.) rather than astigmatism. The optimal adjustment for each degree of freedom x was derived using linear algebra to define the residual force, and setting the derivative to be zero. Equation 1 below shows the result of this derivation:

$$x_{optimal} = \frac{\sum_i a_i \left(\frac{\partial F}{\partial a_i} \right)^2 \frac{\partial a_i}{\partial x}}{\sum_i \left(\frac{\partial F}{\partial a_i} \right)^2 \left(\frac{\partial a_i}{\partial x} \right)^2}, \quad (\text{Eq. 1})$$

where

$x_{optimal}$ is the optimal adjustment of radial position or clocking to minimize force,

a_i are the values of Zernike coefficients before making the adjustment (in $\mu\text{m rms}$),

$\frac{\partial F}{\partial a_i}$ is the mirror stiffness for changing shape that matches Zernike coefficient i (in $\text{N rms}/\mu\text{m rms}$),

$\frac{\partial a_i}{\partial x}$ is the sensitivity of the Zernike coefficient i to a unit displacement of x .

The error analysis for the measurement was performed using a perturbation-type analysis using the optical design code Zemax™, where each degree of freedom for the optical test was perturbed by the amount defined by its tolerance and the effect on the optical test was simulated directly. Only the tilt of the segment was adjusted as a compensator in the model, which will be performed in the real test to bring the light into the interferometer and to “fluff out” the fringes. The resulting wavefront for the perturbed model was written to a file for subsequent processing.

The assumption is that the GMT segment would be manufactured with an error identical to the testing error, which would have a contribution from each of the parameter tolerances. So we simulate the telescope operation with these errors, one at a time. The segment position is optimized according to the relation above. Then the lowest 16 bending modes are fit and removed from the data. The force required to cause this bending, and the residual errors that are not corrected are recorded. The residual wavefront errors are compiled in terms of the structure function. This process is repeated for all of the degrees of freedom for the optical test, resulting in a complete analysis of the errors, as shown in Table 2.

Table 2. Result of tolerance analysis for the optical alignment of the GMT null test

Element	Parameter	Tolerance (μm)	Radial shift (mm)	Clocking (mdeg)	Correction force (N rms)	Residual surface (nm rms)
hologram	axial displacement	20	0.02	0.25	5.44	11.95
	tilt about y	10	-0.01	0.16	0.99	2.80
	tilt about x	10	-0.02	0.02	3.16	8.27
3.75 m sphere	axial displacement	100	1.23	-0.05	11.12	15.21
	tilt about y	100	0.00	3.11	1.88	4.19
	tilt about x	100	1.04	-0.04	8.05	20.09
	radius	250	-0.40	0.01	2.84	3.10
0.75 m sphere	axial displacement	20	-0.50	0.02	5.02	6.16
	tilt about y	10	0.00	-0.10	2.11	3.14
	tilt about x	10	0.12	-0.01	3.94	9.80
	radius	20	-0.49	0.02	4.98	6.89
GMT segment	axial displacement	200	0.40	-0.02	4.67	8.56
sum in quadrature			1.85	3.13	18.23	33.85

The structure function determined by this error analysis is shown below in Figure 9 where the structure function for the optical test has been subtracted (in quadrature) from the overall mirror specification, showing the allowable structure function for the mirror surface after making the allocation for the alignment of the optical test. It is clear from Table 2 and Figure 9 that the alignment errors assumed for the optical test will not have a significant effect on GMT performance – the actuators need only apply 18 N rms and the effect on the structure function is not significant.

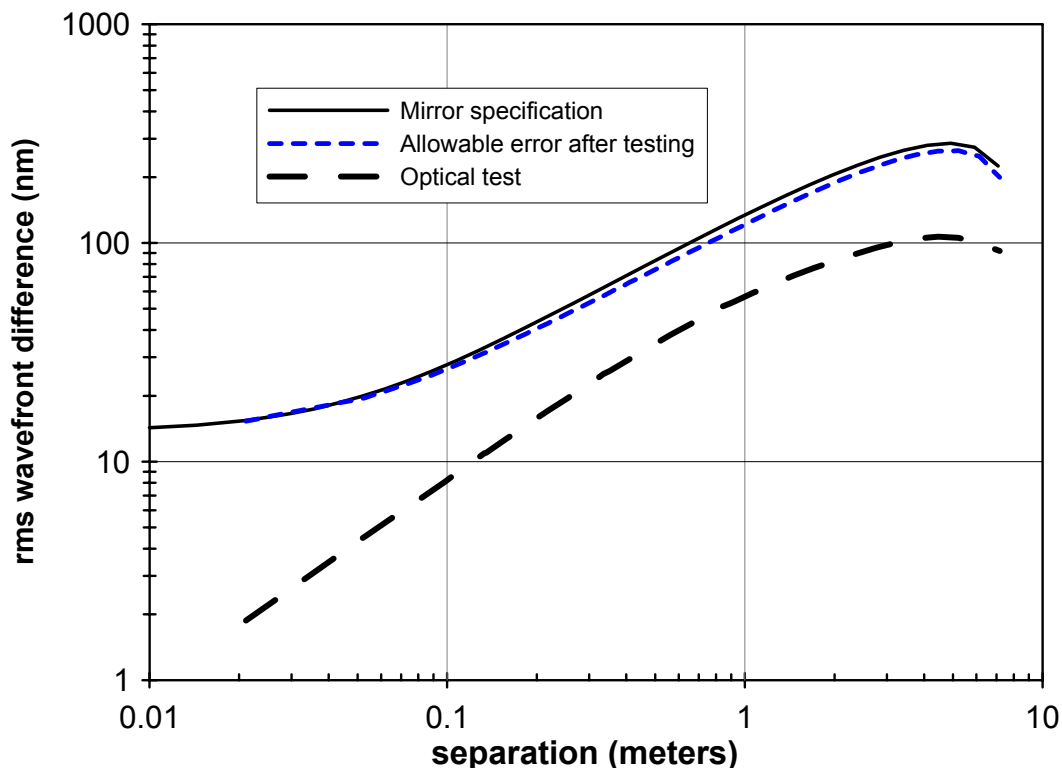

Figure 9. Structure function defined by the alignment errors in the optical test.

Additional errors in the optical test will come from the surface figures of the two mirrors, and from the CGH fabrication errors. These errors will be small, but they will add significant contribution to the testing errors at small scales. The large fold sphere will provide the largest contribution to this error. The test light reflects twice from the fold sphere while it only reflects once from the GMT segment, making the surface more sensitive than what one may expect. We will measure the figure from its center of curvature *in situ* in the optical test and make appropriate corrections to the GMT measurements for errors up to ~10 cycles across. We have set a surface slope requirement of 4 nm/cm rms for the 3.75-m mirror and a requirement to map the data to an accuracy of 1.5 cm. The combination of imperfect mapping and higher order errors that are not backed out is allocated a wavefront structure function budget that is equal to 40% of the mirror structure function.

3. 3.75-METER FOLD SPHERE

The 3.75-m diameter mirror that we use as a fold sphere, shown in Figure 10, will be manufacture at University of Arizona as a lightweight casting of low-expansion borosilicate glass using the same process as that used for the large primary mirrors. Since the fold sphere does not need to be thermally responsive like the primary mirrors, the facesheet thickness was increased from the nominal 28 mm to 38 mm to reduce the small scale errors from both polishing and gravity effects. We require this mirror, to be accurate and lightweight

The 3300-kg fold sphere will be supported face down in the test tower with 48 spring-type actuators, as shown in Figure 12. These apply controlled force, measured with an in-line load cell, and can be adjusted periodically if

necessary. The position of the mirror is constrained using hard points that are nominally unloaded. The actuators will be mounted into a steel cell shown in Figure 11.

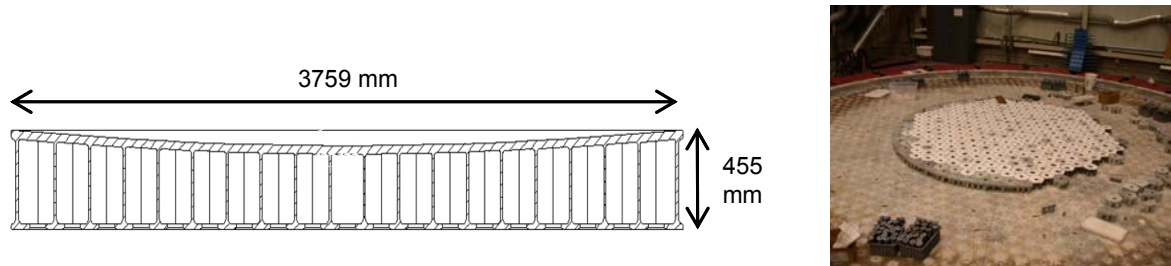

Figure 10. The 3.75-m fold sphere will be made as a lightweight borosilicate casting using the spinning oven at the University of Arizona Mirror Lab. Preparations are now underway to build the mold onto the 8-m hearth.

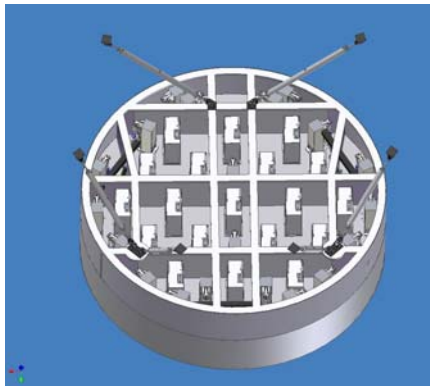

Figure 11. The 3.75-m fold sphere will hang from 48 actuators from a steel cell.

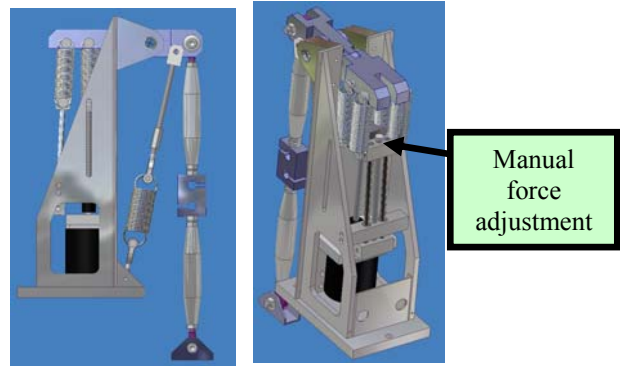

Figure 12. The support actuators use in-line load spreaders and allow a simple mechanical adjustment.

4. TEST TOWER

The optical test for the GMT primary mirror segments requires a new test tower to be constructed at the Steward Observatory Mirror Lab at the University of Arizona. The design of this tower was optimized to allow the testing of GMT and other telescope mirrors, yet not to expand the Mirror Lab. The Mirror Lab is located under the east wing of Arizona stadium, where expansion is extremely difficult. The test tower extends through a thimble in the roof.



Figure 13. Steward Observatory Mirror Lab is located under the bleachers of Arizona Stadium.

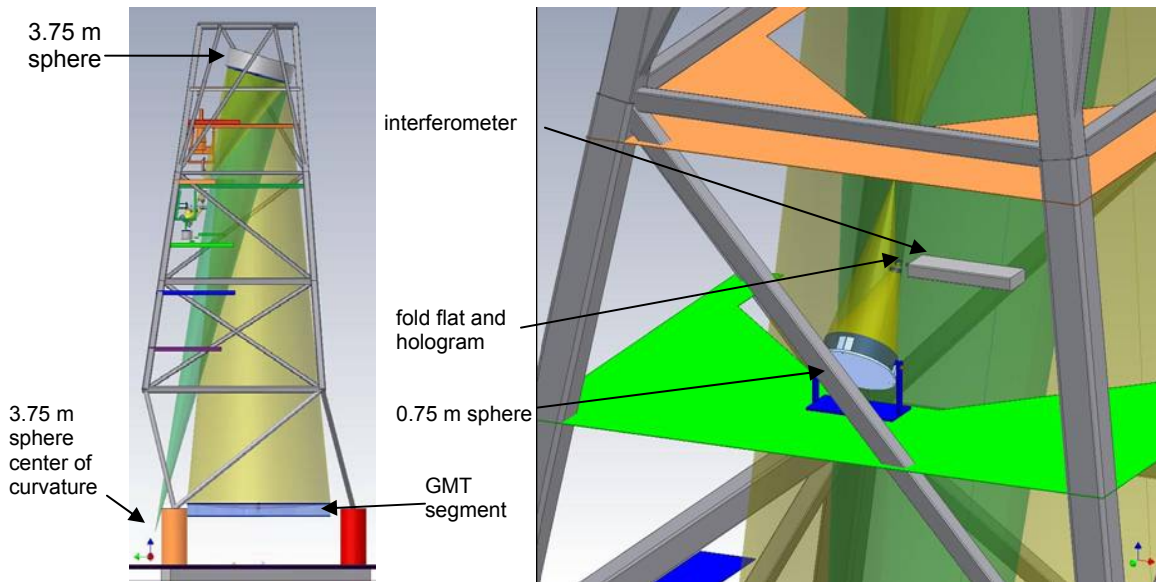

Figure 14. Layout of the GMT test in the new test tower, showing the *in situ* measurement of the 3.75-m fold sphere as well as the GMT segment measurement.

The GMT can be tested within the existing Mirror Lab building, but the original tower, built in 1990, is not sufficient to support the large mirror at the top. The tower is being replaced by a significantly taller and more massive structure that will enable GMT testing, as well as other large 6.5-m and 8.4-m mirrors, including the dual primary-tertiary mirror for LSST. The new tower will stand 29 meters tall, and will require 80 tons of steel. The structure is designed to achieve 4.8 Hz for its lowest mode with the 9-ton fold sphere and cell mounted at the top.

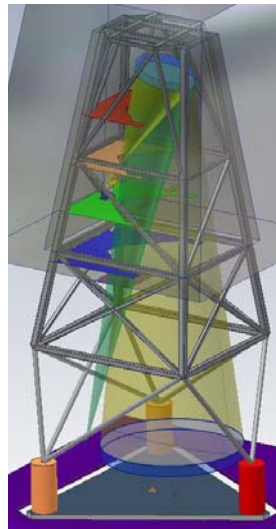
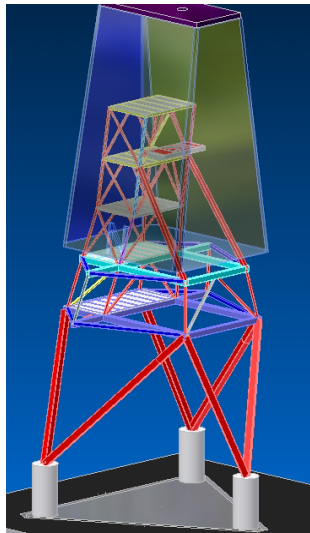

Figure 15. The old test tower at the Mirror Lab (on left) is being replaced by a larger and stiffer structure (on right).

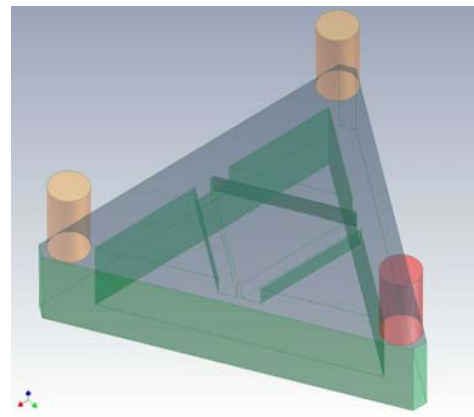

Figure 16. The test tower is built onto columns on a floating triangular concrete pad which is 15 m on a side and 3 m thick. The pad is supported by 44 pneumatic isolators.

The single central segment will be much easier to measure as this mirror is axisymmetric, without such large aspheric departure. To measure this mirror, the 3.75-m fold sphere will be tilted so points straight downward. This mirror folds the path and compensates nearly all of the aspheric departure. A small computer generated hologram provides the additional correction. Similar alignment methods can be used as described above, although this test is not nearly as sensitive to alignment errors.

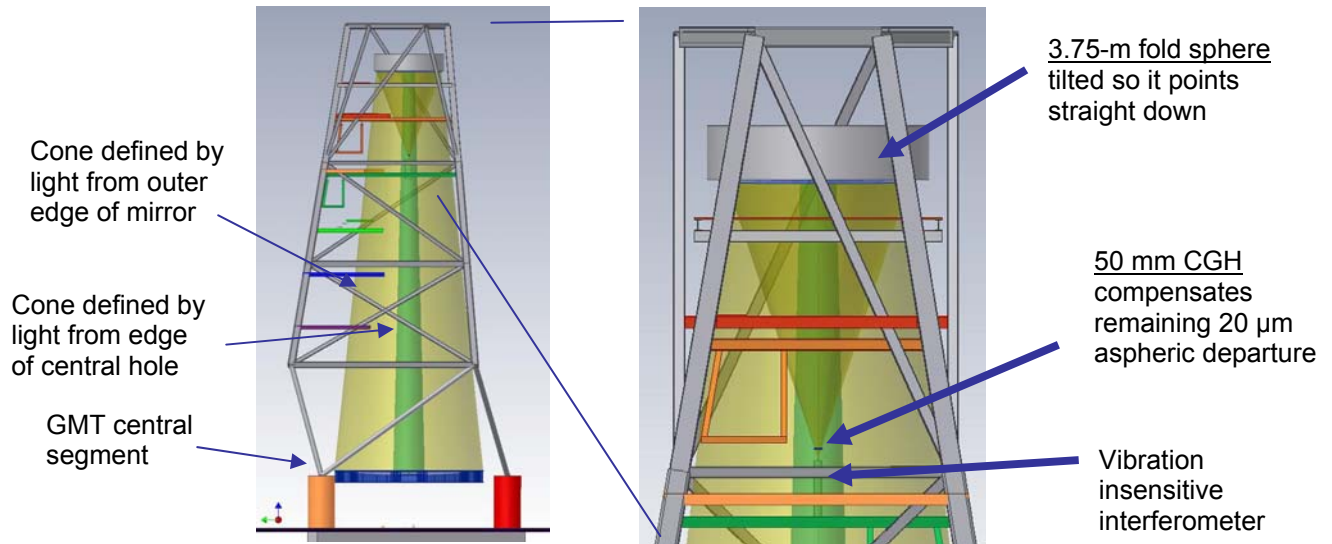

Figure 17. The GMT central segment will be tested using similar hardware, but the 3.75-m fold sphere will be tilted nadir pointing.

5. CONCLUSION

Work is now underway at the University of Arizona to complete detailed designs and to build the hardware to perform the interferometric measurements of the GMT mirror segments.

6. REFERENCES

1. M. Johns, "The Giant Magellan Telescope (GMT)", in *Ground-based and Airborne Telescopes*, ed. L. M. Stepp, Proc. SPIE 6267 (2006).
2. H. M. Martin, J. R. P. Angel, J. H. Burge, B. Cuerden, W. B. Davison, M. Johns, J. S. Kingsley, L. B. Kot, R. D. Lutz, S. M. Miller, S. A. Shtetman, P. A. Strittmatter and C. Zhao, "Design and manufacture of 8.4 m primary mirror segments and supports for the GMT", in *Optomechanical Technologies for Astronomy*, ed. E. Atad-Ettingui, J. Antebi and D. Lemke, Proc. SPIE 6273 (2006; these proceedings).
3. J. H. Burge, T. Zobrist, L. B. Kot, H. M. Martin and C. Zhao, "Alternate surface measurements for GMT primary mirror segments", in *Optomechanical Technologies for Astronomy*, ed. E. Atad-Ettingui, J. Antebi and D. Lemke, Proc. SPIE 6273 (2006; these proceedings).
4. H. M. Martin, R. G. Allen, J. H. Burge, L. R. Dettmann, D. A. Ketelsen, S. M. Miller and J. M. Sasian, "Fabrication of mirrors for the Magellan Telescopes and the Large Binocular Telescope", in *Large Ground-based Telescopes*, ed. J. M. Oschmann and L. M. Stepp, Proc. SPIE **4837**, p. 609 (2003).
5. J. H. Burge, L. R. Dettmann, and S. C. West, "Null correctors for 6.5-m f/1.25 paraboloidal mirrors," *OSA Trends in Optics and Photonics Vol. 24, Fabrication and Testing of Aspheres*, J. S. Taylor, M. Piscotty, and A. Lindquist eds. (Optical Society of America, Washington, DC 1999) pp. 182-186.
6. J. H. Burge, "Certification of null correctors for primary mirrors," in *Advanced Optical Manufacturing and Testing IV*, J. Doherty, Editor, Proc. SPIE **1994**, 248-259 (1993).
7. C. Zhao, R. Zehnder, J. H. Burge, H. M. Martin, "Testing an off-axis parabola with a CGH and a spherical mirror as null lens," in *Optical Manufacturing and Testing VI*, H. P. Stahl, Ed., Proc. SPIE **5869**, 58690X (2005).
8. R. Zehnder, J. H. Burge and C. Zhao, "Use of computer-generated holograms for alignment of complex null correctors", in *Optomechanical Technologies for Astronomy*, ed. E. Atad-Ettingui, J. Antebi and D. Lemke, Proc. SPIE 6273 (2006; these proceedings).
9. H. M. Martin, J. H. Burge, S. D. Miller, B. K. Smith, R. Zehnder and C. Zhao, "Manufacture of a 1.7-m prototype of the GMT primary mirror segments", in *Optomechanical Technologies for Astronomy*, ed. E. Atad-Ettingui, J. Antebi and D. Lemke, Proc. SPIE 6273 (2006; these proceedings).